

30 everel

THE WORLD IN A CLICK

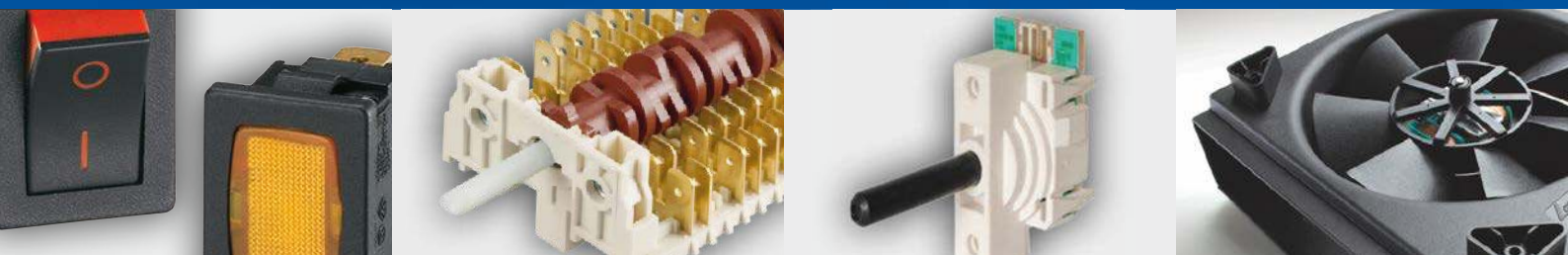

WATERPROOF SWITCHES



Dreefs

 **SIGNAL LUX**

gitem

M MOLVENO

 **KAUTT & BUX**

Waterproof Switches

01



SXL44

100



B4MASK

102



SXA4

104



RMASK

106



SXLR

108



SXL44



TYPICAL APPLICATIONS Steam cleaners

FUNCTIONS

- SPST, momentary or not
- SPST, illuminated or not
- DPST, momentary or not
- DPST, illuminated or not

PROTECTION DEGREE IP 65

CYCLE No. 50.000

CUT OUT 19x13 mm

AMBIENT TEMPERATURE 125 °C

GWT 850 °C

GWT NO FLAME (<2sec) 750 °C on demand

S X L 4 4

DRAWING

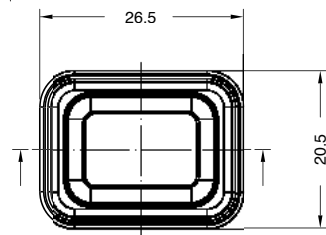
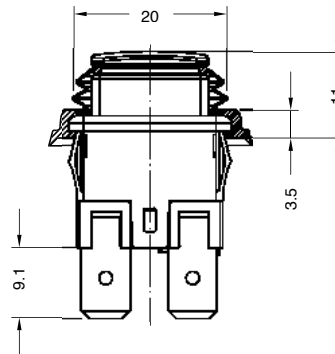
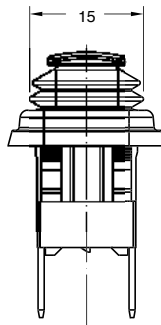

?

TERMINAL

1 Terminal 6.3x0.8

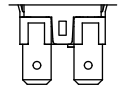

2 Terminal 4.8x0.8

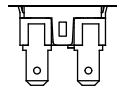

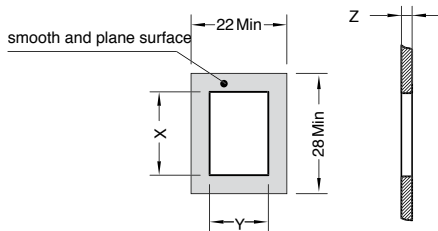

Z	Y	X
0,5 ... 1,2	12,9 $^{+0,1}_0$	19,0 $^{+0,2}_0$
1,2 ... 2,0	12,9 $^{+0,1}_0$	19,3 $^{+0,2}_0$

S	X	L	4	4	TERMINAL	FUNCTION	RATING	RUBBER COLOUR	BUTTON COLOUR	MARKING COLOUR	MARKING	0	0	W

?	?	?	?	?	?	?	0	0	W

FUNCTION RATING RUBBER COLOUR BUTTON COLOUR MARKING COLOUR MARKING

1

2

4

6

7

8

R

H

16 (4) / 250 VAC
 10 (6) / 250 VAC - 5E4
 T125 / 55 °C
 EN 61058

16A - 3/4 HP
 125 / 250 VAC
 T 100 °C
 UL 1054

1 black

2 white

R red

M white

N black

ILLUMINATED

G red

H orange

E green

L white

F blue

X custom

0 none

1 black

2 white

X custom

0

1

R

X



B4MASK



TYPICAL APPLICATIONS	Outdoor electrical equipments, pumps, high pressure cleaners
FUNCTIONS	<ul style="list-style-type: none"> ■ SPST ■ DPST, illuminated or not ■ DPCO
PROTECTION DEGREE	IP 65
CYCLE No.	50.000
CUT OUT	30x22 mm
AMBIENT TEMPERATURE	120 °C
GWT	850 °C
GWT NO FLAME (<2sec)	750 °C on demand

B 4 M A S K

?

DRAWING

TERMINAL

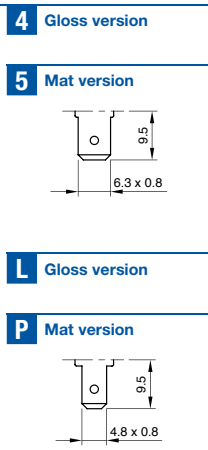
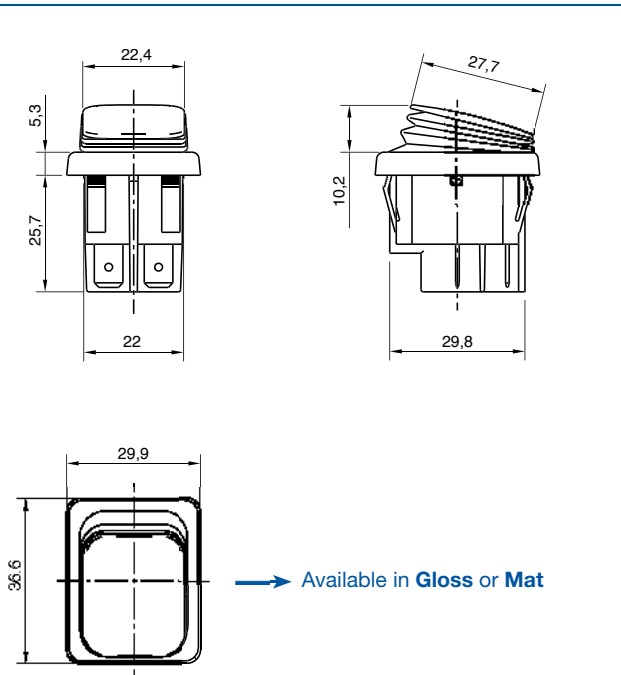
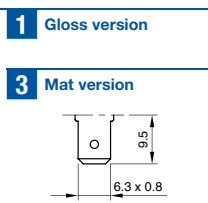
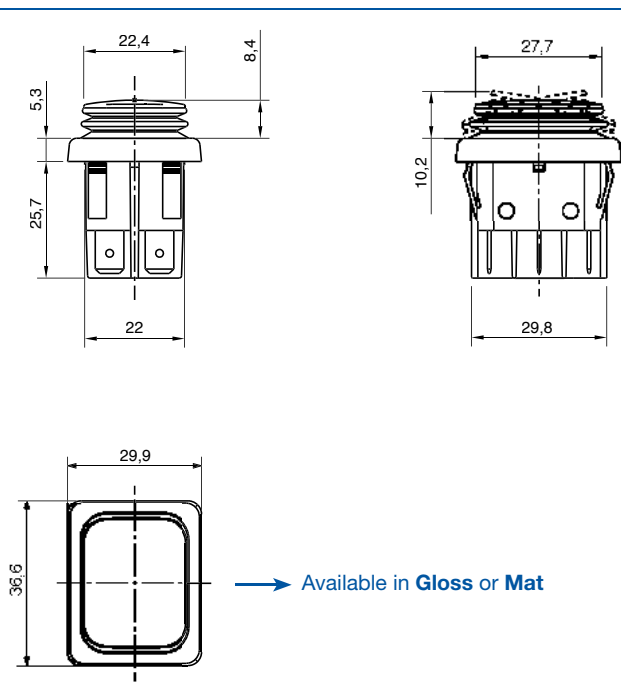

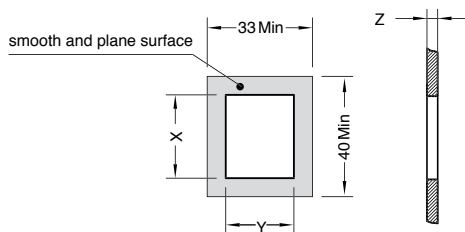

Z	Y	X
0,75 ... 1,25	22,0 ^{+0,2} ₀	30,2 ±0,1
1,25 ... 2,0	22,0 ^{+0,2} ₀	30,6 ±0,1
2,0 ... 3,0	22,0 ^{+0,2} ₀	30,8 ±0,1

TERMINAL	FUNCTION	RATING	RUBBER COLOUR	ROCKER COLOUR	MARKING COLOUR	MARKING
B	4	M	A	S	K	0 0 0

?	?	?	?	?	?	?	0	0	0
FUNCTION	RATING	RUBBER COLOUR	ROCKER COLOUR	MARKING COLOUR	MARKING				

1

2

8

9 Terminal 1 - 3

C

Function 9

16 (6) A / 250 VAC
10 (4) A / 250 VAC - 5E4
T120/55 °C
EN 61058

20 A / 125 VAC
 16 A / 250 VAC
 1/3 HP - 125 VAC
 3/4 HP - 250 VAC
 T105 °C
 UL 1054
 CSA C22.2

E

Function 1

16 (8) A / 250 VAC
12 (10) A / 250 VAC - 5E4
T120 / 55 °C
EN 61058

20 A / 125 VAC
 16 A / 250 VAC
 1/3 HP - 125 VAC
 3/4 HP - 250 VAC
 T105 °C
 UL 1054
 CSA C22.2

N

Function 2 - 8

16 (8) A / 250 VAC
12 (10) A / 250 VAC - 5E4
T120/55 °C
EN 61058

20 A / 125 VAC
 16 A / 250 VAC
 3/4 HP - 125 / 250 VAC
 T105 °C
 UL 1054
 CSA C22.2

S

Function 2 - 8

20 (10) A / 250 VAC
14 (14) A / 250 VAC - 5E4
T120/55 °C
EN 61058

25 A / 125 VAC
 16 A / 250 VAC
 3/4 HP - 125 / 250 VAC
 T105 °C
 UL 1054
 CSA C22.2

1

black

1

black

2

white

3

orange

ILLUMINATED

G

red

E

green

L

white

F

blue

BRIGHT

A

orange

V

green

X

custom

0

none

1

black

2

white

X

custom

0

1

A

9

X

X



SXA4

TYPICAL APPLICATIONS	High pressure cleaners, ironing steam generators, industrial machines, cutters
FUNCTIONS	■ DPST, illuminated or not
PROTECTION DEGREE	IP 54, IP 55 for version with silicone
CYCLE No.	50.000
CUT OUT	30x22 mm
AMBIENT TEMPERATURE	125 °C
GWT	850 °C
GWT NO FLAME (<2sec)	750 °C on demand



S X A 4

?

?

DRAWING

TERMINAL

FUNCTION



O-RING

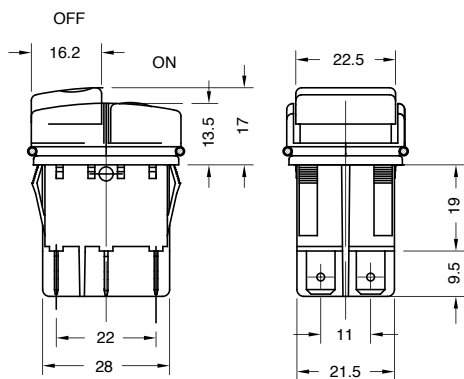

1 Standard

4 With silicone

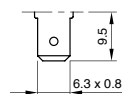

2

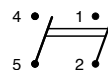

8

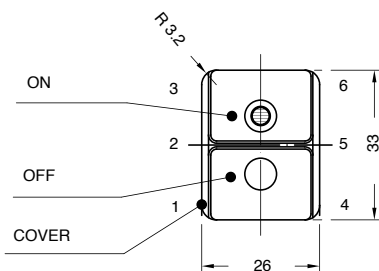
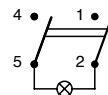

GASKET

3 Standard

5 With silicone

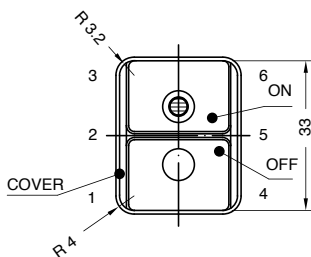
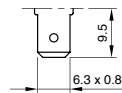
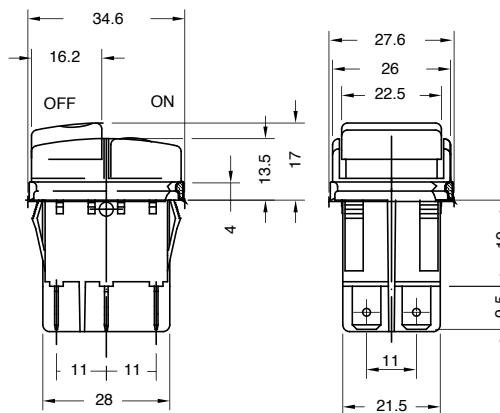

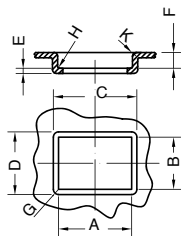
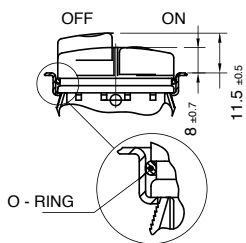

POS.	DIM.	TOL.
K	1.2	±0,1
H	R.0.6	+0.2
G	R.3.5	-0.1
F	5.5	+0.2
E	0.7/3.5	
D	26.6	±0.1
C	33.6	±0.1
B	22	+0.1
A	30	+0.2

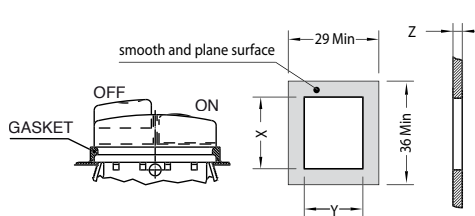

POS.	DIM.	TOL.
Z	0.7/3.5	
Y	22	+0.1
X	30	+0.2

TERMINAL	FUNCTION	RATING	FRAME COLOUR	BUTTON COLOUR ON	BUTTON COLOUR OFF	MARKING COLOUR	MARKING ON	MARKING OFF	LENS COLOUR		
S	X	A	4							0	0

RATING	FRAME COLOUR	ON	OFF	MARKING COLOUR	MARKING ON	MARKING OFF	LENS COLOUR		
?	?	?	?	?	?	?	?	0	0

RATING **FRAME COLOUR** **BUTTON COLOUR** **MARKING COLOUR** **MARKING** **LENS COLOUR**

8
Function 2
 16 (8) A / 250 VAC
 10 (6) A / 250 VAC - 5E4
 10 (4) A / 400 VAC
 T125/55 °C
 EN 61058
 16 A - 125 / 250 VAC
 3/4 HP - 125 / 250 VAC
 T105 °C
 UL 1054
Function 8
 16 (8) A / 250 VAC
 10 (6) A / 250 VAC - 5E4
 T125/55 °C
 EN 61058
 16 A - 125 / 250 VAC
 3/4 HP - 125 / 250 VAC
 T105 °C
 UL 1054

1 black
X **?** custom

1 black
X **?** custom

0 none
2 white
X **?** custom

Marking ON
0
2
3
5
ON
X

0 none
ILLUMINATED
G red
L white
X **?** custom

9
Function 2 - 8
 12 (10) A / 250 VAC - 5E4
 T85 °C
 UL 1054

Marking OFF
0
1
4
OFF
X



RMASK

TYPICAL APPLICATIONS	Steam cleaners, ironing generators
FUNCTIONS	<ul style="list-style-type: none"> ■ SPST, illuminated ■ DPST, illuminated or not
CYCLE No.	50.000
CUT OUT	ø 20 mm
AMBIENT TEMPERATURE	125 °C
GWT	850 °C
GWT NO FLAME (<2sec)	750 °C on demand



R M A S K ?

DRAWING

?

TERMINAL



1

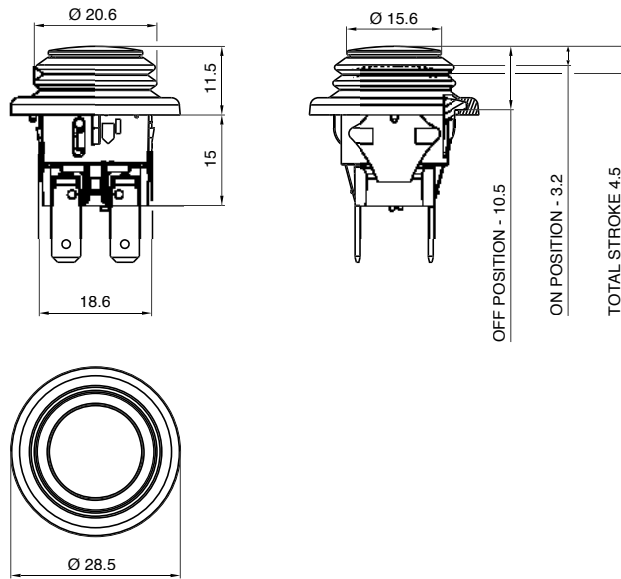

2

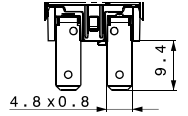

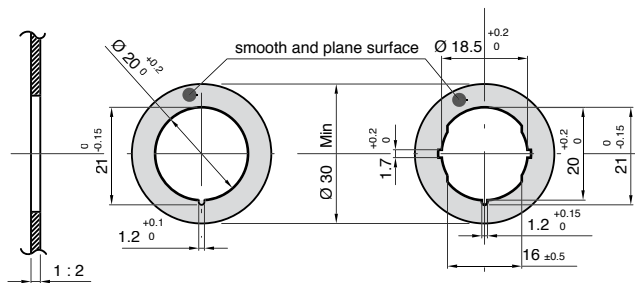

R	M	A	S	K	DRAWING	TERMINAL	FUNCTION	RATING	RUBBER COLOUR	BUTTON COLOUR	0	0	0	0	0
---	---	---	---	---	---------	----------	----------	--------	---------------	---------------	---	---	---	---	---

?

FUNCTION

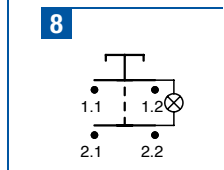
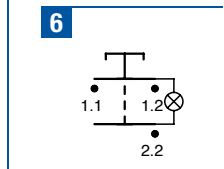
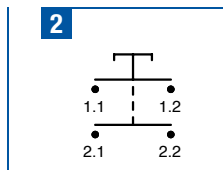

?

RATING

C

16 (6) A / 250 VAC
 12 (10) A / 250 VAC
 8 (8) A / 250 VAC - 5E4
 T125 / 55 °C
 EN 61058

16 A - 125 / 250 VAC
 1 / 2 HP - 125 VAC
 3 / 4 HP - 250 VAC
 T65 °C (T100 °C on demand)
 UL 1054

?

RUBBER COLOUR

1

black

?

BUTTON COLOUR

N

black

M

white

ILLUMINATED

E

green

F

blue

G

red

H

orange

X

custom

0 0 0 0 0



SXLR

TYPICAL APPLICATIONS	Steam cleaners
FUNCTIONS	<ul style="list-style-type: none"> ■ SPST, illuminated ■ DPST, illuminated or not
CYCLE No.	50.000
CUT OUT	ø 25 mm
AMBIENT TEMPERATURE	125 °C
GWT	850 °C
GWT NO FLAME (<2sec)	750 °C on demand



S X L R

?

DRAWING

TERMINAL

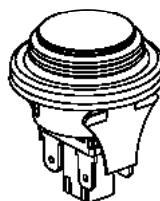
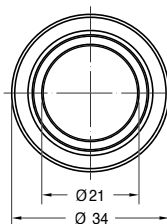
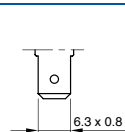
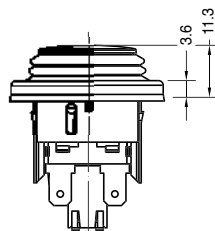
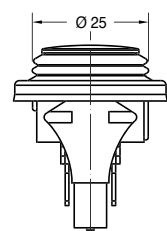

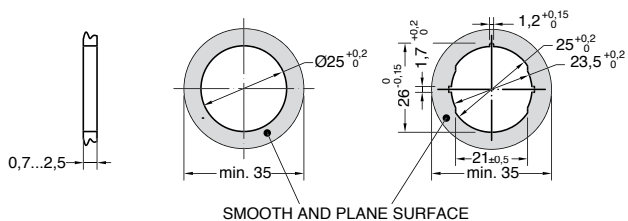

S	X	L	R	TERMINAL	FUNCTION	RATING	RUBBER COLOUR	BUTTON COLOUR	MARKING COLOUR	MARKING	0	0	0
---	---	---	---	----------	----------	--------	---------------	---------------	----------------	---------	---	---	---

?	?	?	?	?	?	?	?	?	?	?	0	0	0
---	---	---	---	---	---	---	---	---	---	---	---	---	---

FUNCTION RATING RUBBER COLOUR BUTTON COLOUR MARKING COLOUR MARKING

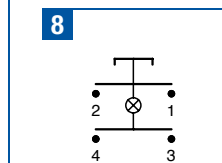
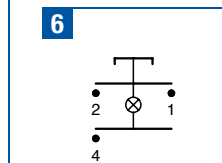
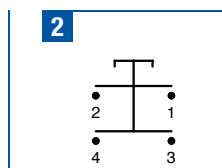

C
16 (4) A / 250 VAC
10 (2) A / 250 VAC - 5E4
T125 °C
EN 61058
 12 A - 125 / 250 VAC
 1/4 HP - 125 VAC
 1/2 HP - 250 VAC
 T100 °C
 UL 1054
 IP65

- 1** black
- 2** white
- X** custom

- M** white
- N** black

ILLUMINATED

- G** red
- H** orange
- E** green
- L** white
- F** blue

- X** custom

- 0** none
- 1** black
- 2** white
- X** custom

- 0**
- D**
- P**
- R**
- X**



- Headquarter
- Production Site
- Sales Network



Everel Group S.P.A.

[Headquarter - Production Site]

Via Cavour, 9

37067 Valeggio sul Mincio (VR) - Italy

tel. +39 045 6313711

fax +39 045 6313730

Dreefs GmbH

[Production Site]

Ernst-Dreefs-Straße 7

96364 Marktrodach - Germany

tel. +49 9261 9610

fax +49 9261 961248

Everel Romania S.r.l.

[Production Site]

Calea Timisorii 109

Lipova - Arad - Romania

tel. +40 257 563087

fax +40 257 563086

www.everelgroup.com

